

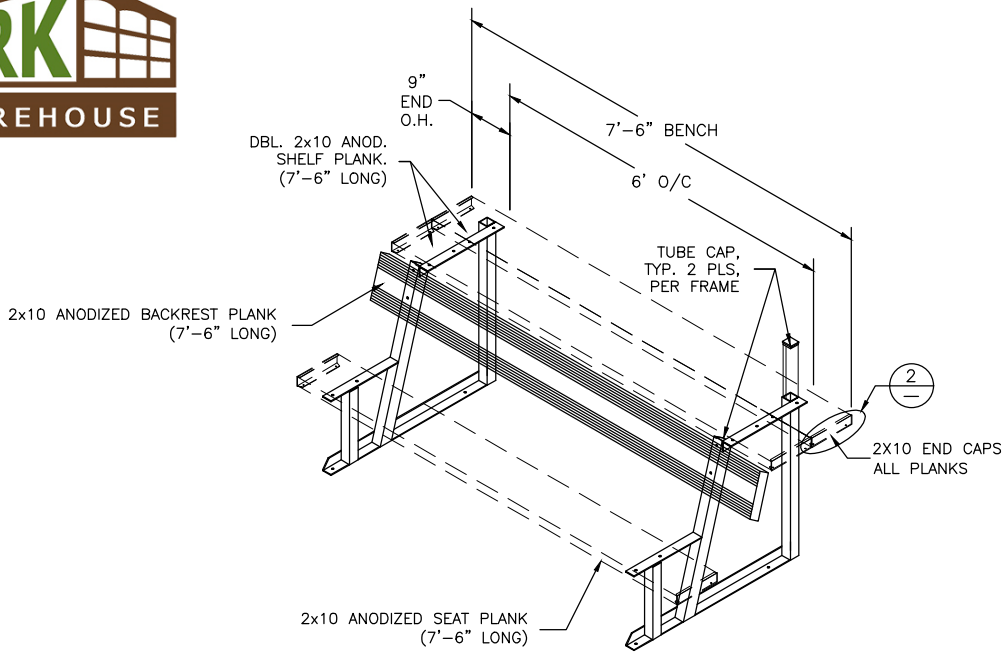

SEE DETAILS 3 & 4 FOR ANCHORING OPTIONS

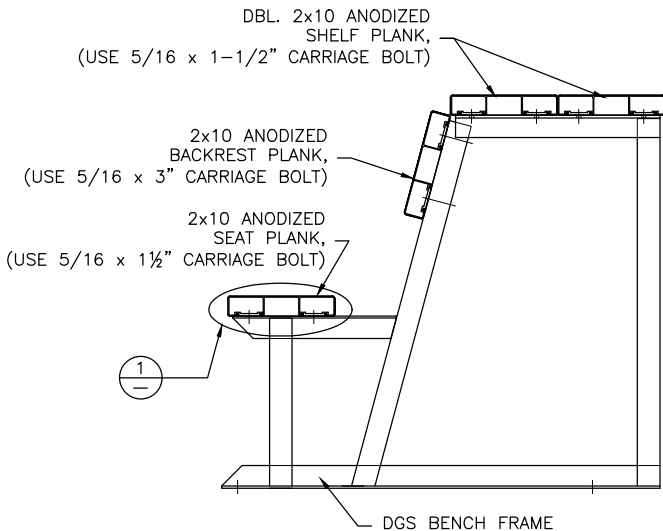

ISOMETRIC VIEW OF BENCH ASSEMBLY
Note: Seat Plank Shown Dotted for Clarity



SIDE VIEW OF BENCH ASSEMBLY

3 TYP 2x10 PLANK ATTACHMENT

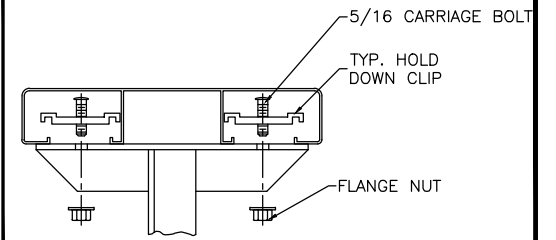

NOT TO SCALE

2 TYP 2x10 ENDCAP ATTACHMENT

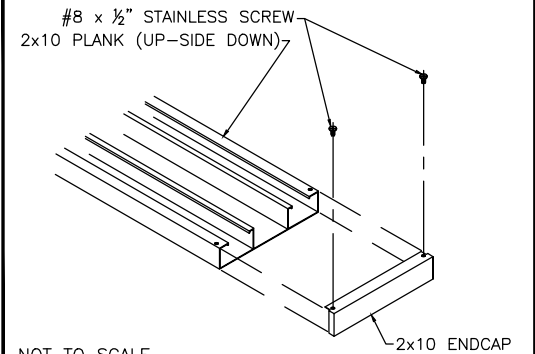

NOT TO SCALE

4 TYP ANCHORING DETAIL

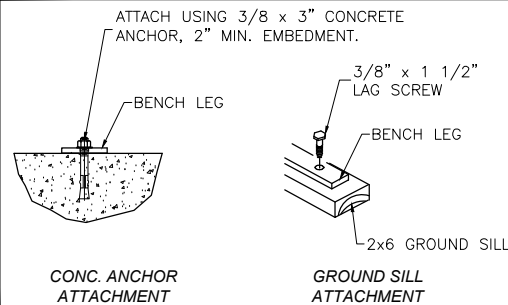

NOT TO SCALE

5 RUBBER FOOT PAD ATTACH. DETAIL

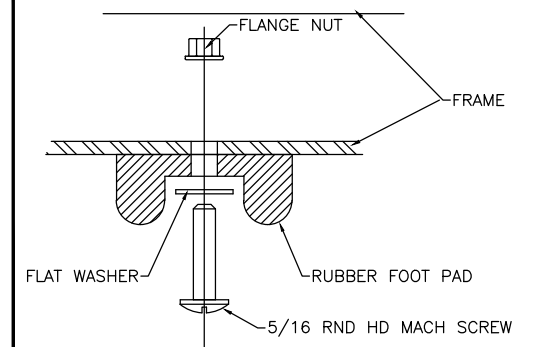

This drawing and all information contained herein is the property of PARK WAREHOUSE, LLC. and is not to be reproduced without express written permission of this manufacturer. We assume no responsibility for unauthorized use of this drawing. PARK WAREHOUSE, LLC. is not responsible for local permits and occupancy requirements.

Park Warehouse, LLC

7495 W. Atlantic Ave. Suite 200-294, Delray Beach, FL 33446

SCALE: NTS	APPROVED BY:	DRAWN BY: JLB
DATE: 11/12/12		
TITLE: 'DGS' BENCH ASSEMBLY 7'-6" LONG		
CUSTOMER:		DRAWING NUMBER: 335be610-2