

SEE DETAILS 3 & 4 FOR ANCHORING OPTIONS

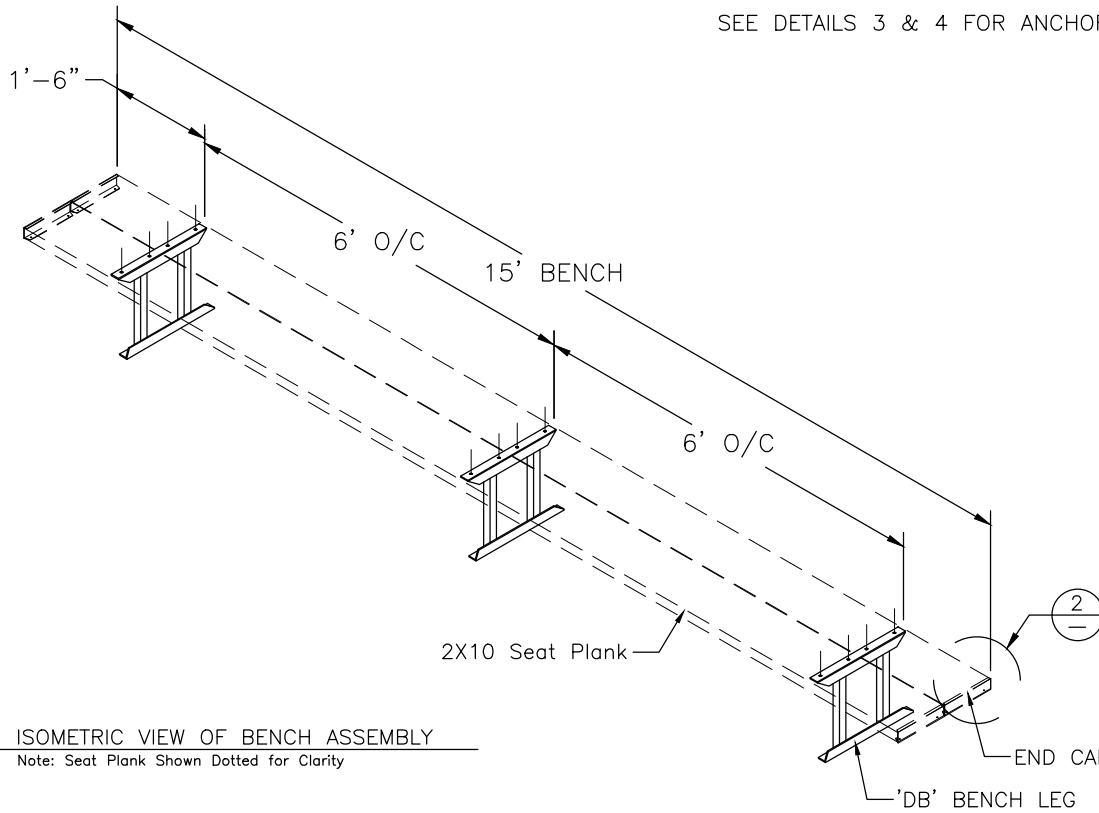

ISOMETRIC VIEW OF BENCH ASSEMBLY

Note: Seat Plank Shown Dotted for Clarity

1 TYP 2x10 PLANK ATTACHMENT

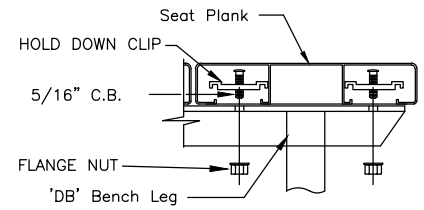

NOT TO SCALE

2 TYP 2x10 ENDCAP ATTACHMENT

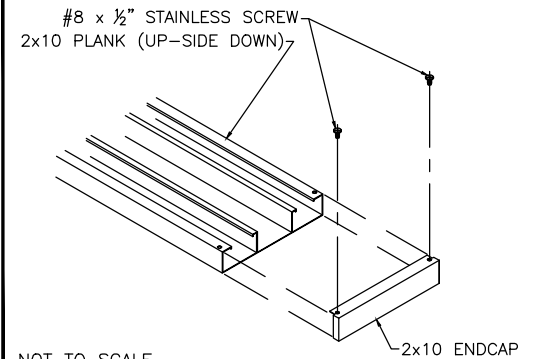

NOT TO SCALE

3 TYP ANCHORING DETAIL

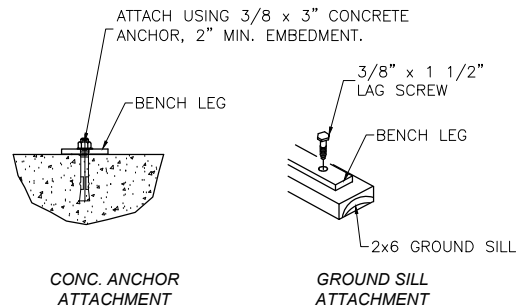

NOT TO SCALE

4 RUBBER FOOT PAD ATTACH. DETAIL

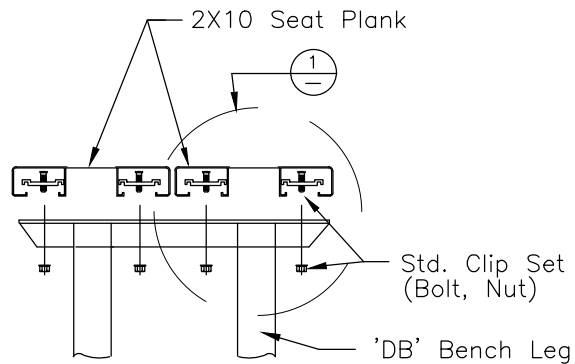
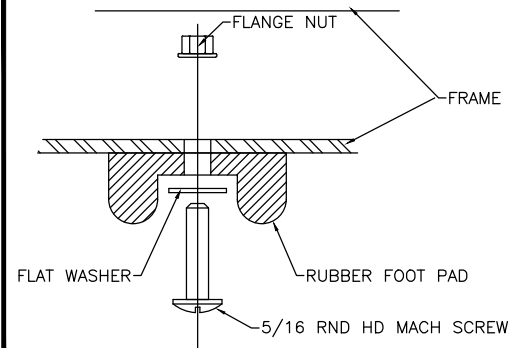

SIDE VIEW OF BENCH ASSEMBLY

This drawing and all information contained herein is the property of PARK WAREHOUSE, LLC. and is not to be reproduced without express written permission of this manufacturer. We assume no responsibility for unauthorized use of this drawing. PARK WAREHOUSE, LLC. is not responsible for local permits and occupancy requirements.

Park Warehouse, LLC

7495 W. Atlantic Ave. Suite 200-294, Delray Beach, FL 33446

SCALE: NTS	APPROVED BY:	DRAWN BY: JML
DATE: 08/11/2016		
TITLE: 'DB' PORTABLE BENCH W/O BACK, 15'-0" LONG		
CUSTOMER:	DRAWING NUMBER: 335be600-4	