

ROLLING RACK



Simple Security

The graceful design and high security of the Rolling Rack has made this type of bike rack a standard for many schools and communities. The Rolling Rack can be used as a single-sided or double-sided parking bike rack. This rack uses thick pipe construction and allows for one of the wheels and frame to be secured using a u-style bike lock.

554br330

Just your size.

The Rolling Rack is available in 4 lengths to meet your bike parking capacity needs.

RR2H
38"
5 Bikes

RR3H
63"
7 Bikes

RR4H
87"
9 Bikes

RR5H
111"
11 Bikes

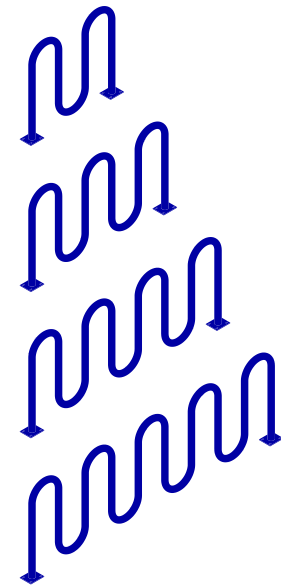

FINISH OPTIONS

Galvanized

Stainless



Powder Coat

White	Black	Light Gray RAL 7042	Deep Red RAL 3003	Yellow RAL 1023
CNH Bright Yellow	Orange RAL 2004	Blue RAL 5005	Sky Blue RAL 5015	Hunter Green RAL 6005
Light Green RAL 6018	Green RAL 6016	Sepia Brown RAL 8014	Bronze	Silver 9007
Dark Purple	Flat Black	Wine Red RAL 3005	Beige RAL 1001	Iron Gray 7011

Thermoplastic

Black	Green	Red	Blue	Gray	Brown
-------	-------	-----	------	------	-------

ROLLING RACK

Submittal Sheet

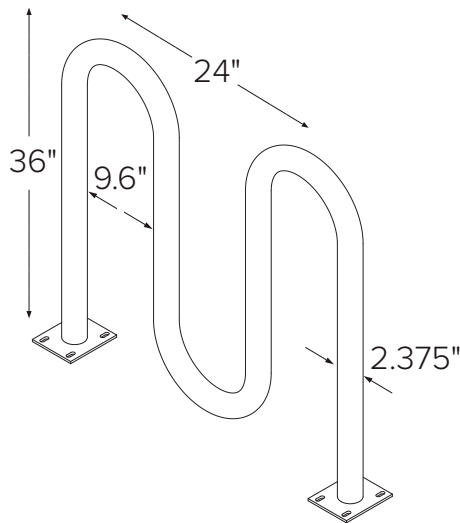

CAPACITY

RR2H: 5 Bikes
RR3H: 7 Bikes
RR4H: 9 Bikes
RR5H: 11 Bikes

MATERIALS

- Standard**
2.375" OD Schedule 40 Steel Pipe
- Lightweight**
2.375" OD Schedule 10 Steel Pipe

FINISHES

- Galvanized**
An after fabrication hot dipped galvanized finish is our standard option.
- Powder Coat**
Our powder coat finish assures a high level of adhesion and durability by following these steps:
1. Sandblast
2. Epoxy primer electrostatically applied
3. Final thick TGIC polyester powder coat

- Thermoplastic**
In addition to an increased thickness (8-10mils), the thermoplastic finish covers a galvanized layer and offers superior impact resistance over powder coating.

- Stainless**
Stainless Steel: 304 grade stainless steel material finished in either a high polished shine or a satin finish.

MOUNT OPTIONS

- In-ground**
In ground mount is embedded into concrete base. Specify in ground mount for this option.
- Surface**
Foot Mount has two 5"x6"x.25" feet with four anchors per foot. Specify foot mount for this option.

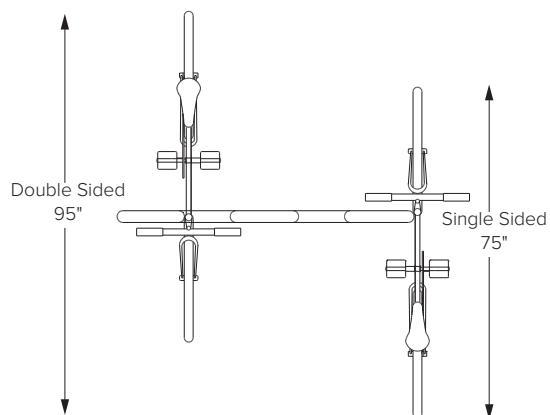
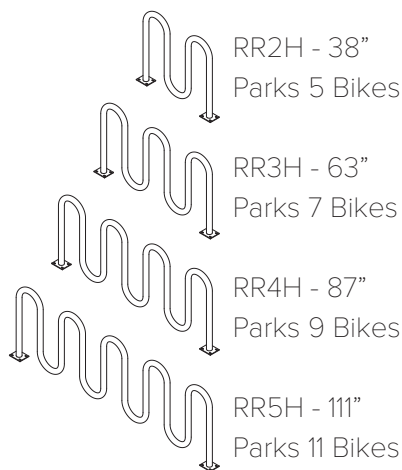

ROLLING RACK
Setbacks

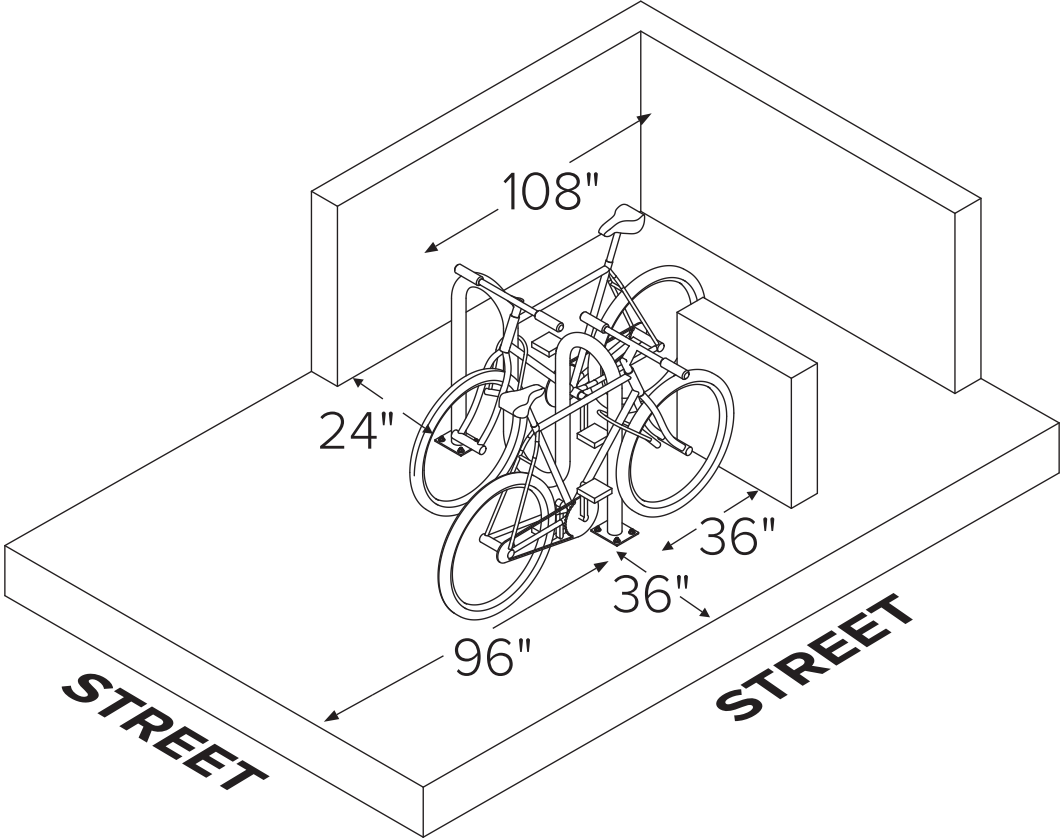

ROLLING RACK

Installation Instructions – Surface Mount

TOOLS NEEDED

Tape Measure
Marker or Pencil
Masonry Drill Bit
Drill (Hammer drill recommended)
Hammer
Wrench or ratchet 9/16"
Level

RECOMMENDED BASE MATERIAL

Solid concrete is the best base material for installation. To ensure the proper anchors are shipped with your rack, ask your representative which anchor is appropriate for your application. Be sure nothing is underneath the base material that could be damaged by drilling.

1

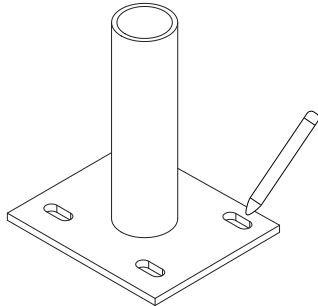

Place the rack in the desired location. Use a marker or pencil to outline the holes of the flange onto the base material.

2

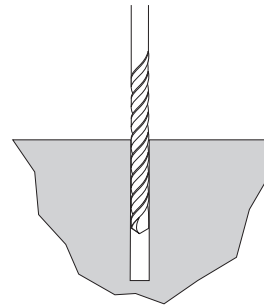

Drill 3/8" diameter holes 3" deep into surface. Make sure the holes are at least 3" away from any cracks in the base material.

3

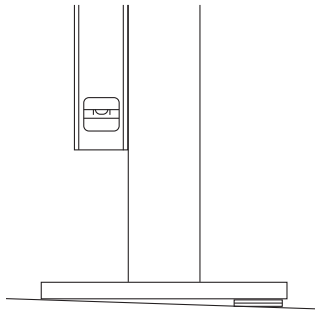

Place rack (and washers to level rack if necessary) over holes.

4

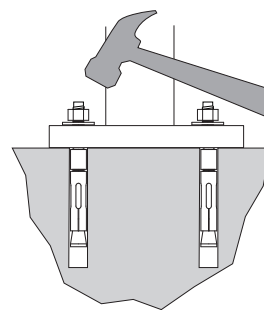

Thread nuts onto anchors, leaving approximately 1/4" of the anchor protruding, and tap into surface. Tighten nuts down to secure rack.

ROLLING RACK

Installation Instructions – In Ground Mount

TOOLS NEEDED

Level
Cement mixing tub
Shovel
Trowel

Hole coring machine with 4" bit
Access to water hose
Materials to build brace (see "Install Tip" at bottom of page)

INSTALLING INTO EXISTING SIDEWALK

Core holes no less than 3" diameter (4" recommended) and 10" deep into sidewalk. Fill holes with Por-Rok or epoxy grout. Place rack into holes, making sure the rack is level. 33"-36" of the rack should remain above the surface. If the rack is less than 33" high, it will not support the bike adequately. Make sure the rack is level and held in place until the grout has set.

INSTALLING INTO A NEW SIDEWALK

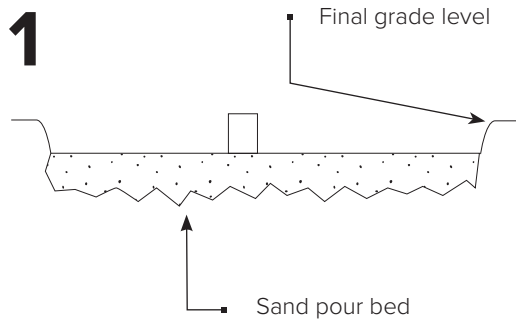

Place corrosion resistant sleeve (min. 3" inside diameter) in sand pour bed in exact location where rack will be installed. Make sure top of sleeve is at same level as desired finished concrete surface. Fill sleeve with sand to keep it in place and prevent it from filling with concrete.

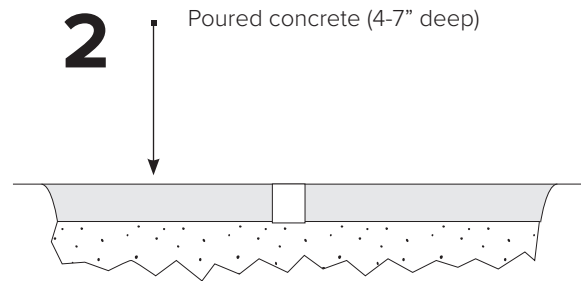

Pour concrete and allow to cure.

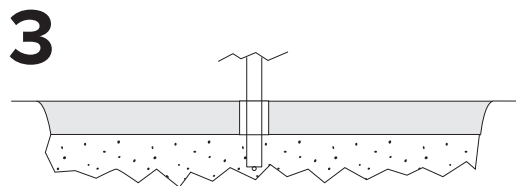

After appropriate cure time, dig out sand from sleeves and insert racks, making sure they are level and at the appropriate height. Pour in Por-Rok or epoxy grout and allow to set.

