

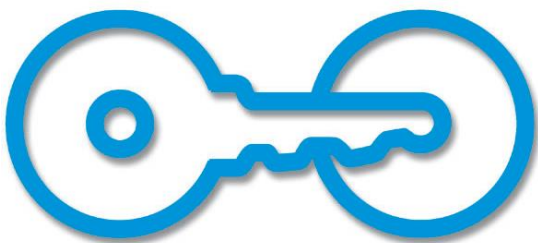

930br350-1 Model 351



High security due to built-in door locks with concealed hinges. Locking bar from top to bottom of door.



Preferred choice by transit agencies across the country.

Fiberglass reinforced plastic construction is highly resistant to impact and scratching.

The finish never needs painting, will not rust or corrode and is extremely resistant to most stains.

The standard key-lock mechanism is completely internal and resists tampering.

Reduced costs due to low maintenance and long life.

930br350-1 Model 351

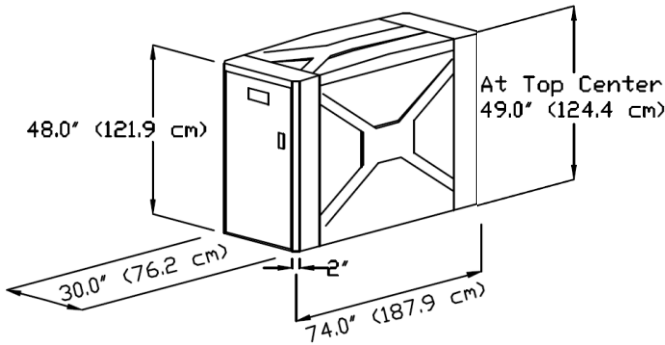

Product 930br350-1 Model 351

Capacity 1 door/1 Bike

Materials Molded composite lockers shall be manufactured with fiberglass reinforced plastic with a smooth "X" and "Y" pattern on stippled walls and top, with smooth door frame and stippled door. Finish allows easy removal of graffiti and is resistant to impact, scratches and U.V. damage. Lockers shall not use an external or internal frame. Walls and top shall be double wall construction for high strength and insulation from the elements resists impact plus chemicals and stains. Materials will withstand extremes in temperature and other weather/environmental conditions. The locker body components shall be joined by internal fasteners.

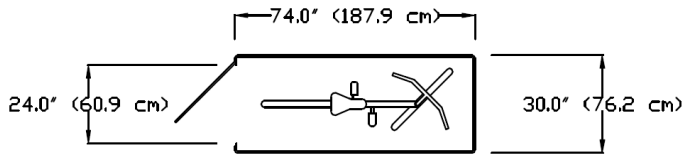

Setback Please allow 5ft clearance for both doors

Hardware Number plates recessed in face of door. Stainless steel louvered vents. Gear hooks for riding accessories.

1 door/1 bike

Internal heavy duty locking hardware consists of a sliding locking bar, 4feet, 2 inches in length which is secured to the door with 1/2 inch stainless steel bolts and rides on Teflon washers. Movement of locking bar is controlled by stainless steel cams attached to the shaft of the lock. High quality heavy duty gauge stainless steel continuous door hinge with not rust. All fasteners and assembly hardware is zinc plated or better.

Adjustable anchor brackets with stainless steel 3/8" anchors allow leveling of lockers.



T-Handle

Padlock/U-Lock Handle

Locks 2 Standard Lock Options
 •High-security, T-Handle Abloy cylinder lock, removable plug-type cylinder. Locker is recessed in the door face.

• Heavy duty stainless steel Padlock/U-Lock handle will accommodate high security Padlocks and U-Locks. For U-Locks from 1/2" to 3/4" Diameter. Padlocks and U-Locks not included.

Colors 7 Standard Color Options

***Please specify Door Number sequence grouping of units.**

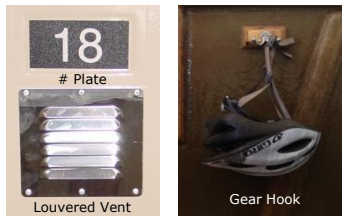

18
Plate

Plate

Louvered Vent

Gear Hook

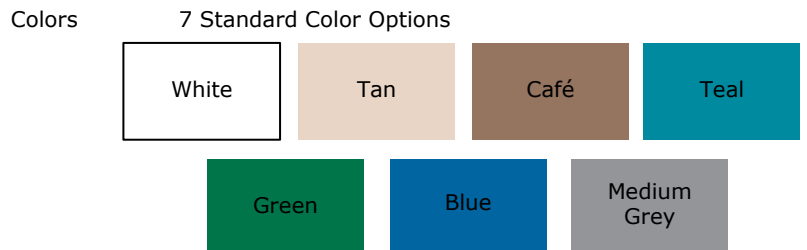

***Please specify grouping of units. For example:**

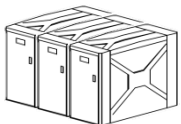

1 group of 3 units, sharing interior walls. Cannot be taken apart.

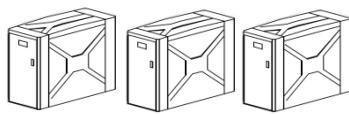

3 Stand-Alone units.

