

SKU: 622be660-9

WARRANTY & TERMS

WARRANTY 5 Year Limited Warranty on Thermoplastic coated elements. Park Warehouse guarantees all items for one full year to be free of defects in workmanship or materials when installed and maintained properly. We agree to repair or replace, any items determined to be defective. Items specifically not covered by this warranty include vandalism, manmade or natural disasters, lack of maintenance, normal weathering or wear and tear due to public abuse.

Damages or loss in transit is the responsibility of the carrier, whether visible or concealed. It is the responsibility of the recipient to assure that the order is received complete. Before signing the delivery receipt, inspect the shipment immediately and completely. Note any damages or shortages on the bill of lading. Damage reports must be filed within 10 days. Park Warehouse is NOT responsible for damages or loss in transit. Title to all goods passes to the customer at the time of shipment. Park Warehouse will assist in filing claims if the freight arrangements were made by Park Warehouse at your request.

CANCELLATIONS AND RETURNS: Cancellations are only accepted with approval of Park Warehouse. No merchandise shall be returned without a Return Goods Authorization number which is issued by customer service. Any authorized merchandise must be carefully packed and received in saleable condition. A restocking charge of up to 25% will be applied to all returned goods when the error is not the fault of Park Warehouse. All returns must be shipped freight prepaid.

SAFETY WARNINGS & EQUIPMENT INSPECTION

- Owners and installers please note these safety warnings and make use of this checklist on a regular basis.
- Follow installation instructions when erecting equipment.
- Ground surfaces around equipment should be restored as needed. Concrete footings should never be exposed. Surface depth should comply with ASTM and CPSC specifications.
- Check for and repair damage caused by wear or vandalism, a major factor in injury causing situations.
- All protruding bolts should be covered or cut off and finished smooth. Sharp edges on pipes should be capped or removed. Check for bent, broken, or severely worn pipe, and replace.
- All equipment should be free of rust and repainted whenever necessary to deter rusting.
- We provide our customers with layout sheets and installation instructions. Please keep on file the specifications sheet that contains the listing of every part used.
- Never add components not intended for use with this product.
- Regular maintenance is necessary in this and all park and recreational equipment to insure the safety of the user.
- Note: Proper maintenance of equipment requires regular tightening of all bolts, nuts, and setscrews.
- Note: Regular checking of all parts, castings, etc. should be made. If a part is broken or worn, it should be replaced immediately.
- Check to be sure all fittings are tight and that bars and pipes do not move.
- Replace all worn S-hooks. S-hooks must be completely closed. Failure to close S-hooks can result in serious injury to the user. NEVER reuse S-hooks.
- Test for free movement of swing hanger and other moving attached parts.
- Check for worn chains and replace them.
- A soft resilient surface should be placed under all swings extending at least twice the height of the top rail both front and back.

HARDWARE

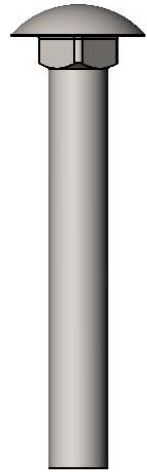

5/16" x 2-1/4"
Carriage Bolt

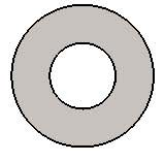

5/16" Washer



5/16" Kep Nut

TOOLS REQUIRED

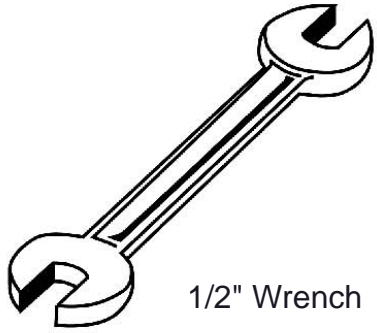

1/2" Wrench

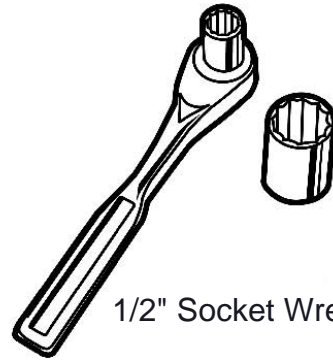

1/2" Socket Wrench



Tape Measure

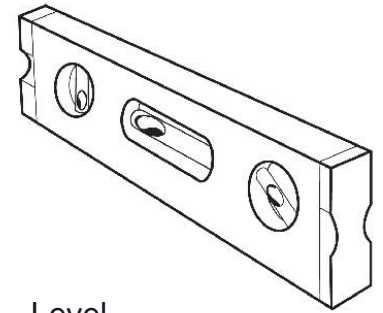

Level

PRODUCT SPECIFICATIONS

CHARLESTON BENCH WITH BACK

Seats: Seats dimensions are 18" x 20" x 72". 12 gauge die formed flat steel plate with precision punched design. End plates are made of 10 gauge flat steel plate. Reinforced with 3/16 x 1-1/2" flat strip. Electrically MIG welded.

Frame: Legs are cast aluminum.

Seat & Frame Coating: Oven fused functionalized polyethylene copolymer-based thermoplastic. Fluidized bed coating application with superior mechanical performance, impact resistance and UV-stability.

Hardware: All stainless steel hardware fasteners.

Dimensions: 6' portable/surface mount bench with back. Seats are 18" wide x 72" long. Seat height is 18" from the ground to the top of the seat. The overall dimensions are 76" x 23" x 35".

INSTRUCTIONS

Attach the 6' Contour Seat to the 964 Legs using specified hardware.

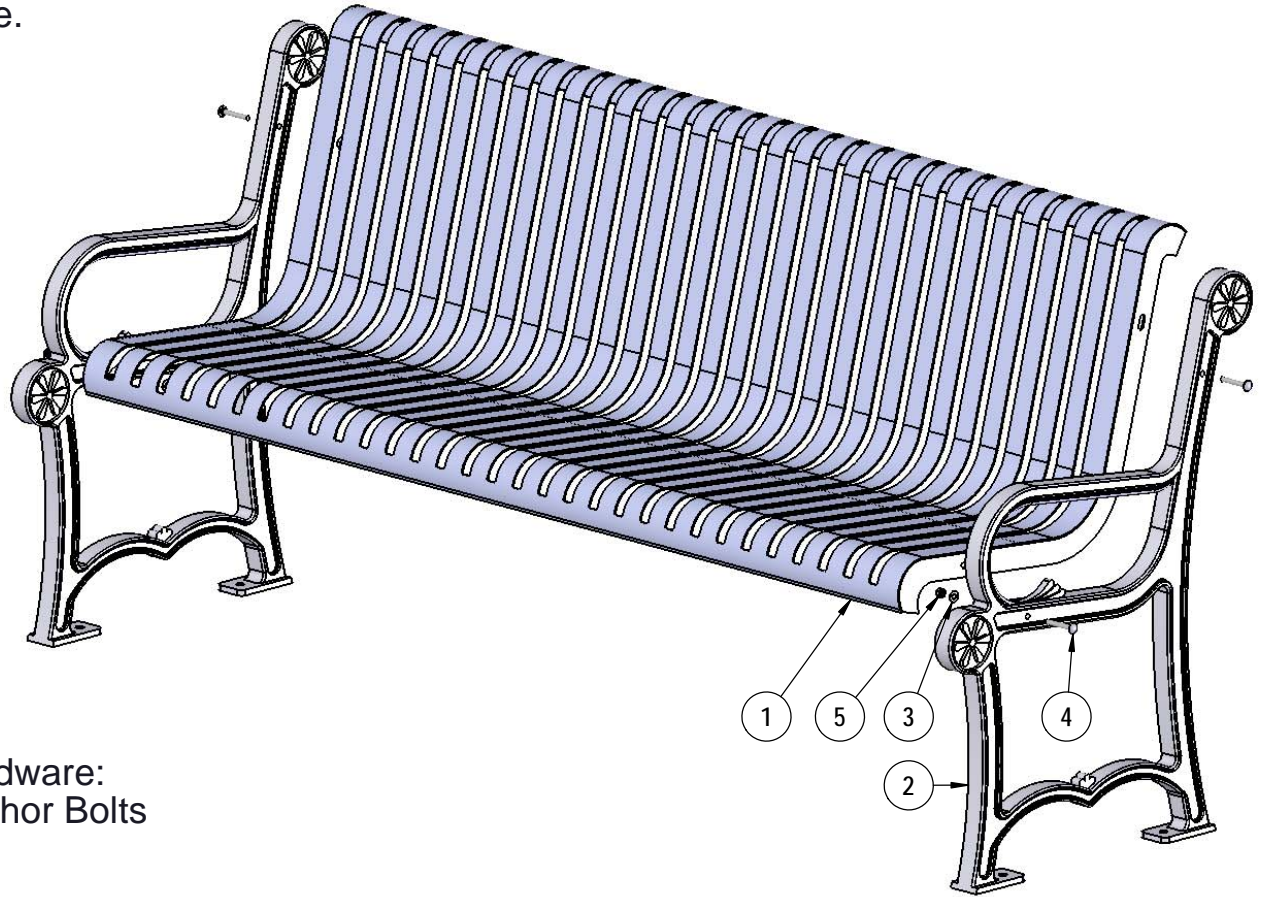

Recommended Surface Mount Hardware:
3/8" x 3-1/2" Concrete Expansion Anchor Bolts
(Not Included)

ITEM NO.	PartNo	DESCRIPTION	QTY
1	T-S72CT-S	6' Slat Contour Seat	1
2	11-01-CAST3	964 Decorative Cast Aluminum End Frame	2
3	33-02-0007	5/16" SS Washer	4
4	33-06-0053	5/16" x 2-1/4" Carriage Bolt (SS)	4
5	33-03-0012	5/16" Kep Nut (SS)	4

OVERALL DIMENSIONS

