

TOP VIEW

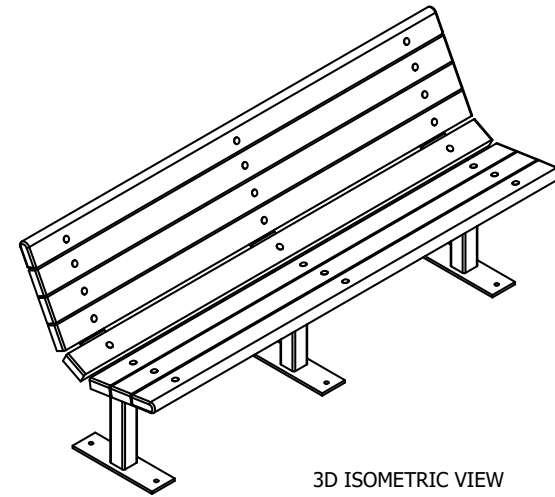

3D ISOMETRIC VIEW

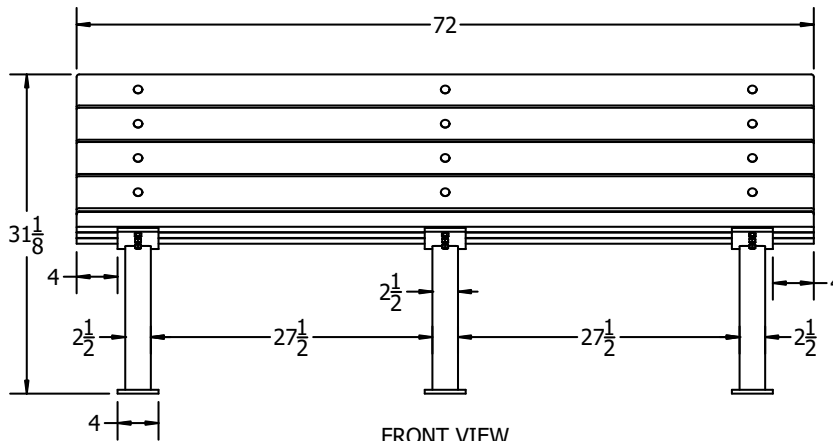

FRONT VIEW

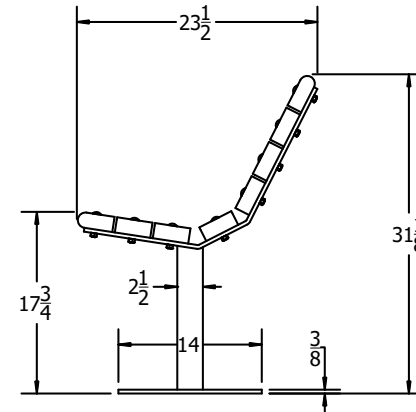

SIDE VIEW

6 ft. Contour Bench Specification Drawing

COPYRIGHT 2013-2033

This drawing and all information contained herein is the property of PARK WAREHOUSE, LLC. and is not to be reproduced without express written permission of this manufacturer. We assume no responsibility for unauthorized use of this drawing. PARK WAREHOUSE, LLC. is not responsible for local permits and occupancy requirements.

Park Warehouse, LLC
 7495 W. Atlantic Ave. Suite 200-294
 Delray Beach, FL 33446
 PH: 888.321.5334
 FAX: 561.288.5279
 WWW.PARKWAREHOUSE.COM

NOT TO SCALE
 Date: 03/2019

